

Data Sheet



Article number: 12621000180000

Description: Industrial tool 621 000 180.000
For M18

Measures

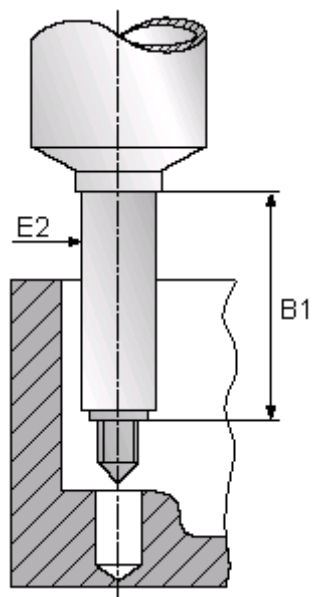

B1	= 60
E2	= 24
For thread	= M18